



A DIVISION OF NORTON VILLIERS LIMITED

motorcycles

**COMMANDO**

**850 AND 750**

**RIDERS  
MANUAL**

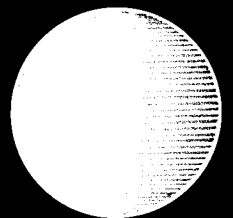

# COMMANDO

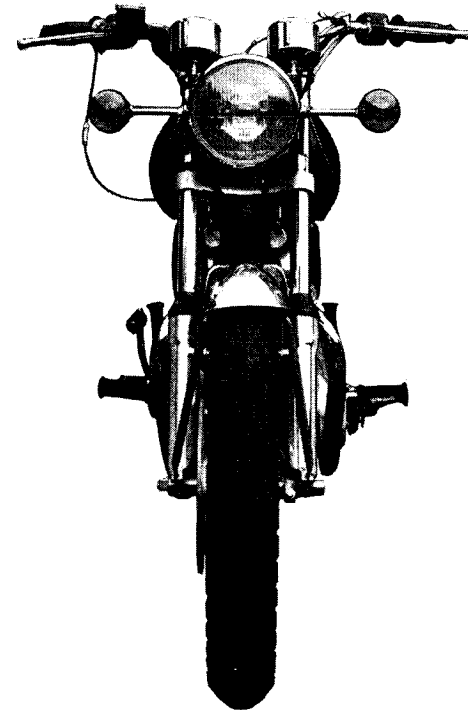

**Norton  
Riders manual  
850 and 750  
models**

---

© copyright

Norton Villiers Ltd.  
Marston Road,  
Wolverhampton,  
WV2 4NW  
England.  
Tel. 22399

Printed in England.  
Part Number 063852

# Contents

Introduction	Page	3
Technical Data		4/5
Lubricants Recommended		6
Lubrication Chart		7
Controls Layout		8
Taking over a new motor cycle		9
Oil levels – checking		9/10
Battery		10
Controls and Instruments – description		12/13
Driving hints		14
Breaking In		15
Fuel		15
Free Service		16
Routine Maintenance		17
Engine oil – changing		18
Oil filters		19
Gearbox oil – changing		19
Primary chaincase oil – changing		19
Rear chain lubrication		19
Front forks		20 and 27
Rear suspension		20 and 27
Engine and Ignition system		21 and 23
Transmission – chain adjustment		26
Clutch		28
Carburetors		29
Wheels – removal		30/31/32
Disc brake		11 and 31
Brakes – adjustment		33
Electrical equipment		35/36
Light bulbs		37
Tracing troubles		38/39

# INTRODUCTION

The Norton Commando is precision built, designed for the discerning rider who desires the ultimate in high speed motorcycling. This motorcycle is designed as a high speed roadster for solo use. IT IS NOT SUITABLE FOR THE ATTACHMENT OF A SIDECAR.

In the construction of the Commando only materials of the highest quality are used, manufacture and assembly being carried out by skilled craftsmen with the care and attention to detail necessary in the production of machines capable of such high performance.

The well proven twin cylinder motor, the result of many years' development, is rubber mounted in a lightweight frame of entirely new design, which ensures superb road holding and smoothness of operation.

Attention is being given to accessibility and maintenance is reasonably simple, most of the servicing being well within the capabilities of the average owner.

This Handbook is intended to provide the owner with the general details of the motorcycle and the instructions necessary to carry out routine maintenance. To ensure the utmost reliability and to maintain the machine in peak condition, these instructions should be carefully observed.

The Handbook does not include information necessary to carry out dismantling for major overhauls. For information of this kind a Workshop Manual is available.

When fitting replacement parts, it is important to use only components manufactured or approved by Norton Villiers Ltd. The full engine number must be quoted to ensure correct identification and prompt supply.

# Technical Data

Engine number: Stamped on crankcase. Frame number: Stamped on frame head lug.  
 Gearbox number: Stamped on gearbox shell.

## Engine 850

Bore 3.031 in. (77 mm).  
 Stroke: 3.503 in. (89 mm).  
 Capacity: 45 cu.in. (827.7 cc).  
 Compression ratio: 8.75 : 1.  
 Engine peak rpm: 5800.

**WARNING:**  
 DO NOT EXCEED 7000 RPM.  
 Rocker clearances (cold):  
 Inlet: 0.006 in. (0.15 mm).  
 Exhaust: 0.008 in. (0.2 mm).

## Engine 750

Bore: 2.875 in. (73 mm).  
 Stroke: 3.503 in. (89 mm).  
 Capacity: 45 cu.in. (745 cc)  
 Compression ratio: 10:1. (H.C.)  
 or 8.9:1 (L.C.)  
 Engine peak rpm: 6,500.

**WARNING:**  
 DO NOT EXCEED 7,000 RPM.  
 Rocker clearances (cold).  
 Inlet: 0.006 in. (0.15 mm).  
 Exhaust: 0.008 in. (0.2 mm).

## Electrical 850 and 750

Ignition timing BTDC:  
 Fully advanced: 28° (engine stationary.)  
 Contact breaker points gap:  
 0.014/0.016 in. (0.35/0.4 mm).

Spark plug: Champion N7Y  
 Spark plug gap:  
 0.023–0.028 in. (0.59–0.72 mm).

## Gear ratios

Rear wheel sprocket:

Standard gearbox sprocket — 21T

	42T	44T	45T
Top	4.38	4.18	4.087
Third	5.30	5.058	4.945
Second	7.87	7.511	7.344
First	11.21	10.698	10.461

Rear wheel sprocket:  
 42T All 750/850 except USA Roadsters  
 44T USA 850 Roadsters only  
 46T USA 750 Roadsters only

## Chain sizes

Primary:  $\frac{3}{8}$  in. Triple row (92 pitches).

Rear:  $\frac{5}{8}$  in. by  $\frac{3}{8}$  in.

## Capacities

Fuel tank: Interstate 5.84 Imp (7.3 US) gallons 26.57 litres  
 Roadster (Steel) 2.50 Imp (3 US) gallons 11 litres  
 Roadster (Glassfibre) 2.25 Imp (2.70 US) gallons 10 litres  
 Oil tank: 5 Imp (6 US) pints 2.8 litres  
 Gearbox: .75 Imp (.9 US) pints .42 litres  
 Interpol 4 Imp (4.8 US) gallons 18.16 litres  
 Hi-Rider 2 Imp (2.3 US) gallons 9.1 litres  
 Primary Chaincase: 200 cc. (7 fl. oz.)  
 Front Forks: 150 cc. (5 fl. oz.) each leg

## Carburetors (850 Engine)

Type: Amal 932 (dual) 32 mm  
 Main jet: 280 without muffler mutes  
 280 with muffler mutes  
 Throttle valve: No. 3.  
 Needle jet: 0.106.  
 Needle position: Top notch without or with muffler mutes.

## Carburetors (750 Engine)

Type: Amal 932 (dual). 32 mm  
 Main jet: 220 without muffler mutes.  
 210 with muffler mutes.  
 Throttle valve: No. 3.  
 Needle jet: 0.106.  
 Needle position: Middle notch without muffler mutes.  
 Top notch with muffler mutes.

## Dimensions

Overall length: 87 $\frac{1}{2}$  in. (221 cm).  
 Overall width: 26 in. (65 cm).  
 Ground clearance: 6 in. (15.24 cm).  
 Weight: 385–395 lb (174.6–179.125 Kg)  
 dependent on specification.  
 Wheelbase: 56 $\frac{3}{4}$  in. (144.1 cm).  
 Seat height (rider seated): 31 in. (78.7 cm).

## Tires

Front: 4.10 by 19 in GP or TT100 on WM2 wheel rim.  
 Rear: 4.10 by 18 in GP or TT100 on WM3 wheel rim.  
 Tire pressures: (Nominal)  
 Front: 26 lb/psi (1.83 Kg/sq cm).  
 Rear: 24 lb/psi (1.687 Kg/sq cm).  
 For alternative load/pressure figures refer to Workshop Manual

## Note

Do not fit tires other than the stated types and sizes or the handling of the machine may be adversely affected.

Larger section tires may also foul the mudguards (fenders) and stays.

Norton Villiers reserves the right to vary the specification of all motorcycles and spare parts without notice and this information does not therefore constitute a term of any sale. All descriptions and claims are given and made in good faith but are intended to apply generally and variations in performance and construction of individual machines may occur. In particular, performance will be affected by conditions circumstances and the rider.

Efficient lubrication is of vital importance and it is false economy to use cheap grades of oil. When buying oils or grease it is advisable to specify the brand as well as the grade and, as an additional precaution, to buy from sealed containers.

# Lubricants Recommended

UNIT	CASTROL	B.P.	SHELL	MOBIL	ESSO	TEXACO
Engine and Primary Chaincase	Castrol GTX or Castrol XL	BP Super Visco-Static 20W/50	Shell Super Motor Oil	Mobiloil Super or Mobiloil 20W/50	Uniflo	Havoline Motor Oil 20W/50
Gearbox	Castrol Hypov	BP Gear Oil SAE 90 EP	Shell Spirax 90 EP	Mobilube GX90 or HD90	Esso Gear Oil GX 90/140	Multigear Lubricant EP 90
Swinging Arm Bushes	Castrol Hi-Press	BP Gear Oil SAE 140 EP	Shell Spirax 140 EP	Mobilube C140 or HD 140	Esso Gear Oil GX 90/140	Multigear Lubricant EP 140
Hubs and Frame Parts	Castrol LM Grease	BP Energrease LZ	Shell Retinax A or CD	Mobilgrease MP or Mobilgrease Super	Esso Multi Purpose Grease H	Marfak All-Purpose Grease
Front Forks	Castrolite	BP Super Visco-Static 10W/40	Shell Super Motor Oil	Mobiloil Super	Uniflo	Havoline Motor Oil 10W/30
Rear Chain	Castrol Graphited Grease	BP Energrease AO	Shell Retinax A or CD	Mobilgrease MP or Mobilgrease Super	Esso MP Grease Moly	Marfak All-Purpose Grease
Easing Rusted Parts	Castrol Penetrating Oil	BP Penetrating Oil Penetrating Oil	Shell Easing Oil	Mobil Handy Oil	Esso Penetrating Oil	Graphited Penetrating Oil

## APPROVED LUBRICANTS

	Engine and Primary Chaincase	Gearbox	Telescopic Forks	Wheel Bearings, Swinging Forks and Steering Races	Easing Rusted Parts
DUCKHAM'S	Duckham's Q20/50	Duckham's Hypoid 90	Duckham's Q5500	Duckham's LB 10 Grease	Duckham's Adpenol Penetrating Oil
SUN OIL	Sunoco Special Motor Oil	Sunep 1070	Sunoco Special Motor Oil 20W/50	Sunep 1130	—
FILTRATE	Filtrate Super 20W/50	Filtrate EP 90	Filtrate A.T. Fluid 'F'	Filtrate Super Lithium Grease	—

The above lubricants are suitable for all operating temperatures above  $-18^{\circ}\text{C}$  ( $0^{\circ}\text{F}$ ). Approval is given to companies other than those listed above provided they have similar multigrade characteristics and meet the A.P. I. Service SD performance level.

# Lubrication chart

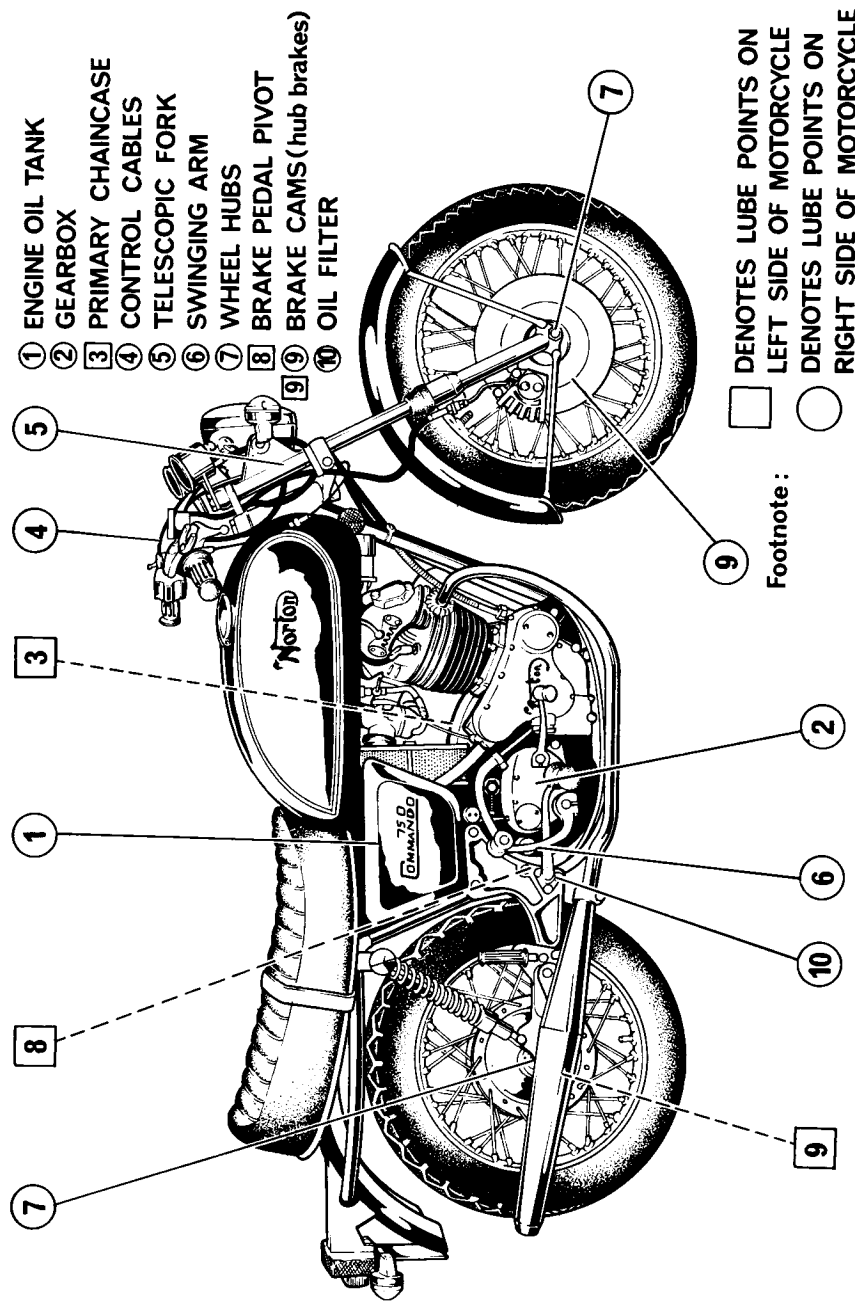

ILLUSTRATION 1

# Controls

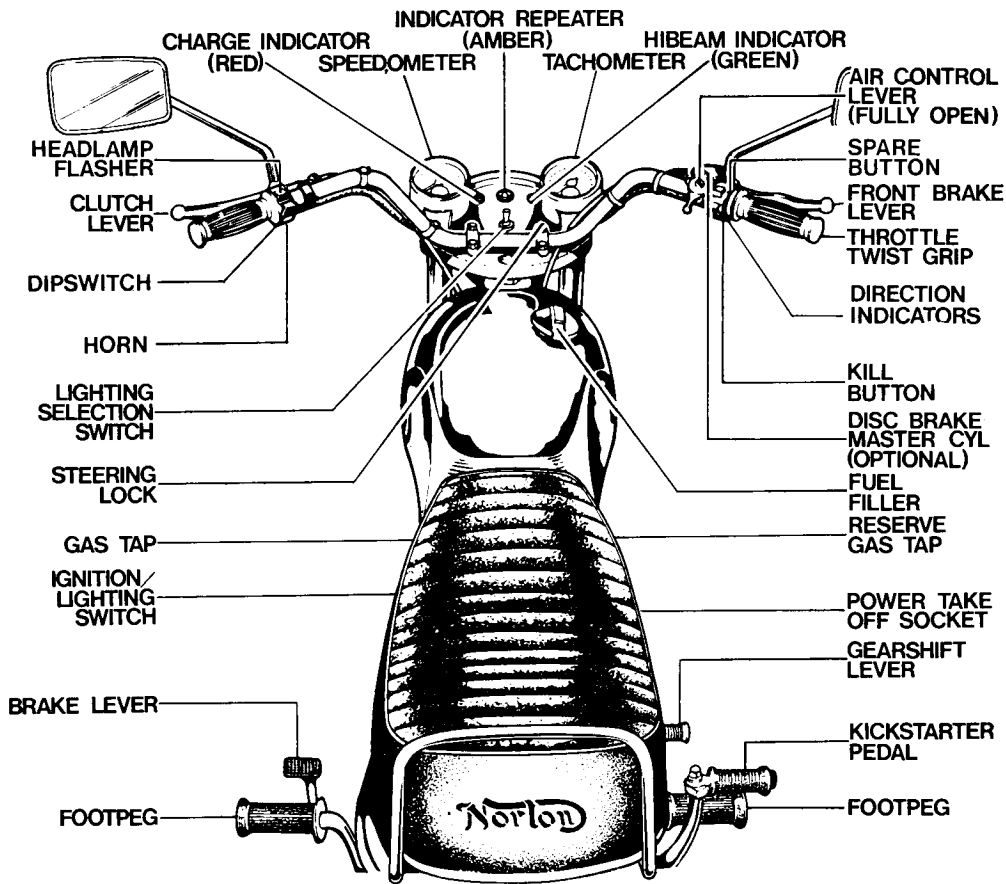

ILLUSTRATION 2

# Taking over a new motorcycle

Before running the engine, spend a few minutes going over the layout of the controls and instruments. Sit astride the motorcycle and adjust the control levers and handlebars to give the most comfortable riding position. Make sure that the oil tank, gearbox and primary chaincase are filled to the correct levels and that the battery is topped up. In the case of disc brake motorcycles, check the master cylinder reservoir level.

Normally these preparations will be carried out by the dealer. The manner in which the various levels are indicated is described below.

## Engine oil tank

The oil tank content is indicated on a dipstick incorporated in the tank filler cap which is removed by turning the cap anti-clockwise.

Access to the tank filler cap is made by: releasing the two hand discs retaining the riders seat, raising the seat slightly rearwards and lifting it clear.

Before filling fresh oil, run the engine for three to four minutes to return excess oil from the crankcase, observing the oil circulating through the oil tank filler orifice.

Allow the oil to settle in the tank, then fill sufficient oil of a recommended grade until the correct oil level is shown on the dipstick. The oil level should not exceed the "H" mark or fall below the "L" on the dipstick. It is most important not to exceed the "H" to prevent the passage of excess oil to the airbox.

## Gearbox

An oil level plug is fitted in the gearbox cover. (See illustration 3).

To check level, remove plug (illustration 3 item B) whereupon oil should seep gently out if level is correct. If topping up is necessary, remove the filler cap (illustration 3, item C) and replenish with correct grade of oil until the oil begins to seep from the level plug orifice. Replace the filler cap and the level plug.

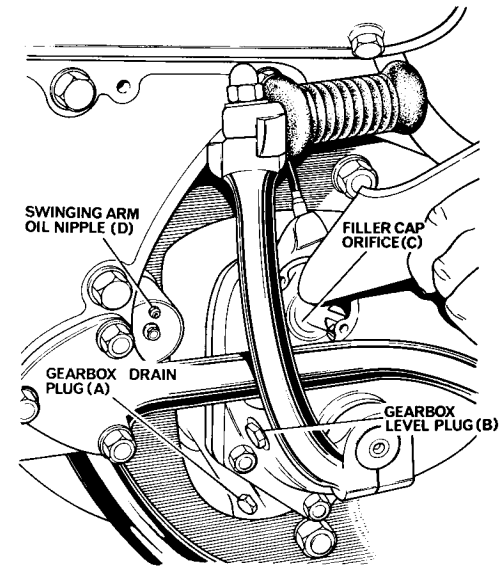

ILLUSTRATION 3

## Primary chaincase

An oil level plug is fitted in the primary chaincase outer cover. (See illustration 4).

To check level, remove plug (illustration 4, item B) whereupon oil should seep gently out if level is correct. If topping up is necessary, remove the filler cap (illustration 4, item C) and replenish with correct grade of oil until the oil begins to seep from the level plug orifice. Replace the filler cap and the level plug.

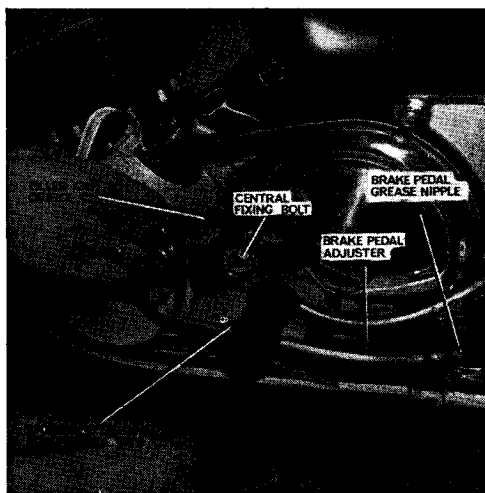

ILLUSTRATION 4

## Battery

For access to the battery remove the side cover by turning the ring above the ignition switch to remove the Dzus fastener. The panel is then lifted out of the front and clear of the rear pegs. To remove the battery lift the metal loop of the rubber strap clear of the battery retaining bar. Disconnect the red ground lead from terminal "+" and the blue/brown lead from terminal "-" on the battery. Slide the vent pipe clear. Lift the battery clear, taking care not to spill acid. When refitting the terminals towards the centre of machine. The electrolyte level is embossed on the battery case, visible on the left side of the battery casing. (See illustration 5 and also page 35).

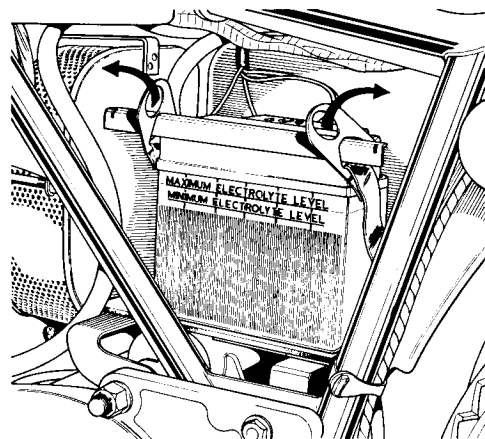

ILLUSTRATION 5

## Disc brake (Alternative)

The disc brake is hydraulically operated. Before taking the motorcycle on the road for the first time ensure that the master cylinder reservoir contains the correct amount of fluid.

The master cylinder contains a flexible bellows seal which fits into the reservoir **over** the fluid. **DO NOT FILL THIS.** Lift the bellows out (see illustration 6) and lay on the upturned cap so that dirt does not adhere. Check that the fluid is to a level of  $\frac{1}{2}$  in. from the top of the reservoir and if necessary, correct the level using the recommended hydraulic fluid. Replace

the bellows seal closed end downwards then refit the cap tightly.

Hydraulic brake fluid absorbs moisture and it is most important to keep the cap on tight and also to store the fluid only in sealed containers. The breather hole in the cap must be kept clear and no dirt or foreign matter must be allowed to enter the system.

## Important

Hydraulic brake fluid must be handled with care as it will attack paintwork certain types of rubber and plastic.

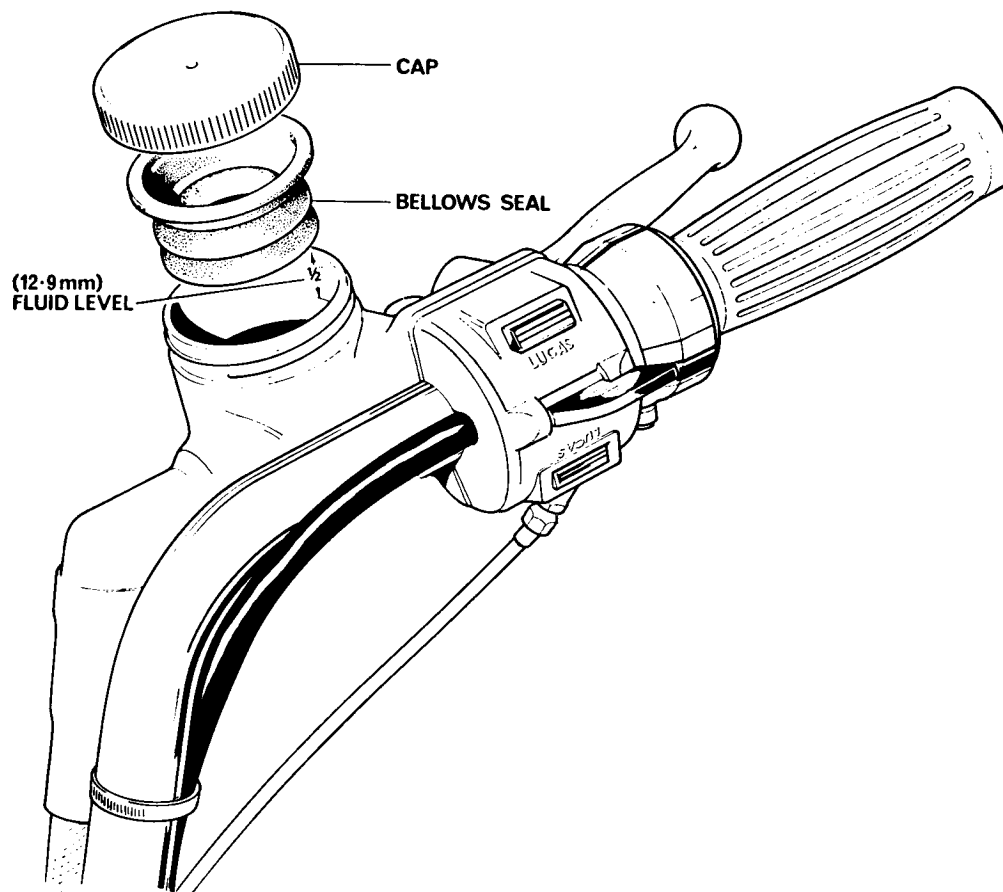

ILLUSTRATION 6

# Controls and instruments

(See illustration 2).

## Throttle twistgrip

This is mounted on the right handlebar and controls the throttle opening and, therefore, the engine speed. An adjuster is provided in the cable to vary the amount of backlash between the twistgrip control and the junction box to the twin carburetors. A spring-loaded friction adjusting screw is located in the twistgrip body.

## Carburetor air control

Mounted on the handlebar this controls the carburetor air slides. For cold starting the control can be closed to provide a rich mixture by moving lever away from rider (to the slack wire position), but should be fully open for normal running with the engine at its normal working temperature.

## Clutch control

The clutch lever is on the left handlebar and when pulled towards the bar with a gear engaged, disengages the drive between the engine and the rear wheel. A knurled cable-adjusting screw is provided to adjust cable backlash.

## Front brake lever

Mounted on the right handlebar. The drum brake lever has a knurled cable-adjusting screw. The disc type brake is self adjusting.

## Headlamp dipper switch, flasher and horn button

These are located on the left handlebar. The two-way switch controls the headlamp main/dipped beams. The top button is the flasher switch and the horn is operated by the bottom button.

## Direction indicator switch and kill button

These are located on the right handlebar. The two-way switch controls the optional direction indicators (up for left and down for right). The bottom button is the kill button and the top button is spare.

## Fuel taps

These are beneath the fuel tank on each side. The right-side tap is 'Reserve'. Both taps must be turned off whenever the machine is parked to avoid damage to engine or carburetor.

## Light selection switch

Located on top of the headlamp shell, the switch selects in the left position, parking lights and in the right position, headlamp and tail lamp.

## Steering lock

This is mounted on the handlebar lug. The lock is operated by a key and effective only with the handlebars turned fully to either right or left.

## Ignition and lighting switch

The four-position switch is attached on the left side of the machine and is operated by a key which can only be withdrawn when the ignition is switched either to the "Parking with lights" position or to the "Lights and Ignition off" position. The switch positions, starting from the anti-clockwise position are:

- (1) Parking with lights (ignition off).
- (2) Lights and Ignition off.
- (3) Ignition only.
- (4) Ignition and lights.

(See illustration 7).

## Gearshift lever

The lever is on the gearbox on the right side of the machine and operates the positive-stop mechanism which returns the lever to a central position when foot pressure is released after each gear change. The neutral position is between first and second gears. Downward movement of the lever selects the higher gears, upward movement selects the lower gears. An indicator is fitted.

The lever is attached to the spindle on splines and can be repositioned to suit individual requirements.

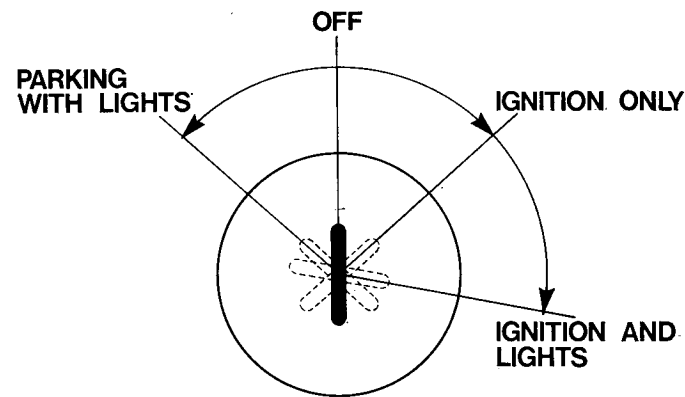

ILLUSTRATION 7

## Kick starter pedal

This is on the right side of the machine.

## Rear brake pedal

The rear brake pedal is on the left side footrest and can be adjusted for height to suit the rider. (Illustration 4 page 10).

## Stop lamp switch

The rear brake stop light switch is located on the rear brake pedal. After the pedal is positioned to suit the rider, care must be taken that the switch functions properly but does not act as the pedal stop. To adjust, loosen the nuts holding the switch and slide the switch in the slots until it is positioned correctly. Tighten the nuts, then make sure that the stop bolt is taking the force of the pedal return, not the switch.

A nonadjustable stop light switch is also included in the front system.

## Speedometer

The speedometer records road speed in miles per hour or kilometres per hour (Continental models only), and the odometer records the total distance covered in either miles or, on Continental models, in kilometres.

## Tachometer

Driven by cable from the camshaft, the tachometer records engine speed in revolutions per minute.

## Tools

The tool kit issued with each new machine is placed in a compartment inside the left side cover. The cover is retained by a Dzus fastener at the top front corner and is supported by two pegs and grommets at the rear.

## Power take off socket

A socket is provided, mounted on the side of the battery tray at the right hand side. A plug is provided also to fix to any useful accessory desired by the rider (e.g. wireless, electric shaver and numerous other items). A maximum of 17½ amps is available at the socket but the rider must appreciate that the heavier the drain of current, the shorter the duration available from the battery. Care must be taken when wiring any accessory to the plug provided, so that the wires are correctly colour coded. Note that this motorcycle is positive earth (ground) and that red indicates earth (ground). Apart from providing a power source, a battery charger may be plugged in at the socket.



# Driving

This motorcycle incorporates a unique frame with special mountings for the engine unit to provide an exceptionally smooth ride. However, some vibration will still be experienced at lower rpm and can be eliminated immediately by a change of speed or gear.

## Starting the engine

Ensure the gear lever is in the neutral position (Gear indicator registers with N on indicator plate).

Switch on the ignition – turn on the left-hand fuel tap.

If the engine is cold depress the carburetor ticklers to flood the carburetors. Do not overflood or starting will be difficult and do not jab the ticklers sharply up and down as this will eventually damage the floats. Close the air control lever.

Open the throttle a little and give a firm downwards swing on the kick starter pedal using the whole weight of the body. After the engine has started, open the air lever as soon as the engine temperature permits.

When restarting with the engine at working temperature it should not be necessary to close the air lever or flood the carburetors.

If starting is difficult owing to flooding, switch off the ignition and turn off the fuel tap. Operate the kickstarter briskly a few times with the air and throttle controls open to clear excess fuel from the combustion chambers. Switch on the ignition, turn the fuel tap on and start in the normal manner.

## Gear changing

To move away from rest, pull the clutch lever and engage first gear by lifting the gear lever upward as far as possible. When the gear is felt to engage, allow the gear lever to return to its normal position. Gently and smoothly release the clutch lever and at the same time open the throttle slightly to give the power necessary to move off.

To change to a higher gear, accelerate gently then close the throttle, pull the clutch lever and press the gear lever downwards to select the next gear. Release the gear lever and the clutch lever and open the throttle. Select the gears in this manner until top gear is reached.

When changing down to a lower gear, the throttle should be opened slightly so that the engine speed is increased to keep in step with the lower gear ratio.

## Use of the gearbox

The gearbox should be used intelligently to keep the engine running smoothly with the least possible stress. The gear ratios are carefully chosen to meet the characteristics of the engine. The rider should at all times select the most suitable gear for the prevailing conditions.

Do not slip the clutch to control road speed. The neutral position must be located and the clutch control released whenever the motorcycle is stationary for any period.

# Breaking in

In the process of manufacture the best possible materials are used and all machined parts are finished to a very high standard but it is still necessary to allow the moving parts to 'bed in' before subjecting the engine to maximum stresses. The future performance and reliability of the engine depends on the care and restraint exercised during its early life.

For the first 500 miles throttle openings should be limited to about one third of twist grip movement and the cruising speed should be varied as much as possible within this limit. Provided the engine is not allowed to labour, the actual road speed is relatively unimportant, but throttle control should be smooth and the gearbox used to the full to enable the engine to cope with the prevailing conditions without undue stress. This will also assist in 'break-in' the gearbox components. At all times avoid violent acceleration.

After the 500 mile service the amount of throttle opening can be increased progressively but the cruising speed should still be varied. Full throttle should not be used until the machine has covered at least 1,000 miles and even then only for short bursts until 1,500 miles has been covered, whereupon maximum performance may be sought whenever desired.

During the 'break-in' period, a certain amount of adjustment will be necessary as the components bed in. Attention should be given to valve rocker adjustment, chain tension, contact breaker points gap and brakes, (excepting disc brake) all of which tend to settle down. (See *Maintenance Instructions*).

Do not allow the oil tank level to fall too low, as with the reduced amount in circulation the oil will become unduly hot.

On motorcycles equipped with the disc brake, it is most essential to avoid glazing of the friction surfaces during the first few miles of use. During the first 50 miles only it is necessary to apply the disc brake gently to mate the friction surfaces. After 50 miles of use, the brake will be fully bedded down and ready for maximum application.

## Fuel

Fuel of not less than 99 octane (premium gas or 4 star British rating) is recommended.

ALTERATIONS TO BASIC RECOMMENDED IGNITION AND CARBURETTOR SETTINGS **MUST BE MADE** TO OPERATE SUCCESSFULLY IN COUNTRIES WHERE NORMAL RECOMMENDED FUELS ARE NOT AVAILABLE

Recommended standard and alternative settings for lower octane fuels

Comp. Ratio	850 8.75 : 1		750 8.9 : 1		750 10 : 1	
	std.	alt.	std.	alt.	std.	alt.
Octane Rating	96	94	99	96	100	97
Main Jet	280	300	220	250	220	250
Ignition Setting	28	28	28	26	28	26

Ignition settings given are maximum Ignition advance (stroboscope) @ 3000 r.p.m. A small power loss is to be expected when grade fuels and associated ignition and carburettor changes are utilised.

## Free Service

All owners of new COMMANDO motor-cycles are entitled to a FREE SERVICE AND INSPECTION at 500 miles, or, at latest, three months after taking delivery.

This service is arranged by the supplying dealer.

The INSPECTION AND SERVICE consists of:

- (a) Check, and, if necessary, adjust:
- (1) Valve clearance.
  - (2) Contact breaker points.
  - (3) Ignition timing (due to nylon heel, etc., settling)
  - (4) Spark plugs.
  - (5) Clutch operation and cable.
  - (6) Chains.
  - (7) Brakes (Not disc)
  - (8) Alignment of wheels.
  - (9) Tire pressures.
- (b) Tighten all external nuts and bolts, including cylinder head nuts, to recommended torque.
- (c) Top-up battery and check all electrical equipment.
- (d) Clean out carburetors and check for correct idling.
- (e) Adjust all cables.
- (f) Grease all nipples except swingin arm which must be oiled.
- (g) Drain oil system. Clean oil tank strainer gauze and replace oil filter element.
- (h) Check oil level in primary chaincase.
- (i) Top-up gear box.
- (j) Optional disc brake – check level.
- (k) Drain and refill front forks.
- (l) Test machine on the road.

It should be noted that whilst the service, time and labour are entirely without charge, all materials including oils and replacements must be paid for.

## Routine maintenance

		<i>See page Number</i>
<b>Weekly</b>	Check tire pressures	5
<b>Every two weeks</b>	Check battery electrolyte level	10
<b>Every 250 Miles</b>	Check engine oil tank level	9
<b>Every 1,000 Miles</b>	Check primary chaincase oil level	10
	Adjust rear chain	26
	Lubricate all control cables with oil	
	Adjust both brakes (optional disc brake is non adjustable)	33
	Check optional disc brake fluid level	11
	Examine disc brake pads for wear	—
<b>Every 2,500 Miles</b>	Check timing and adjust contact breaker points	25/13*
	Clean spark plugs and set gaps	24
	Change primary chaincase oil level	10
	Check clutch adjustment	28
	Check primary chain adjustment	26
	Change engine oil	18
	Relubricate and adjust rear chain	26
	Check gearbox oil level	9
	Check front and rear rubber engine mountings for side play ( <i>see Workshop Manual</i> )*	
	Change oil in forks	20*
	Grease rear brake pedal pivot	10
	(see Illustration 4 on P. 10)	
	Check Isolastic mountings for free play	
	(see Workshop Manual)	
<b>Every 5,000 Miles</b>	Change gearbox oil	19
	Replace oil filter element	19
	Clean contact breaker points	22*
	Lubricate contact breaker cam felt and auto advance unit	22*
	Grease brake expander pivots	7
	(one stroke of grease gun)	
	Check and adjust valve rocker clearances	21*
	Check and adjust camshaft chain	23*
	Fit new air filter element	29
	Check and oil swinging arm bushes	30
<b>Every 10,000 Miles</b>	Re-pack wheel bearings (including the rear wheel sprocket bearing) with grease	
	Dismantle and clean both carburetors and check for wear	29

See Table of Recommended Lubricants on Page 6.

\*FOR RIDERS WITHOUT MECHANICAL EXPERIENCE IT IS RECOMMENDED THAT THE SERVICES MARKED \* ARE CARRIED OUT BY A NORTON DEALER

## Changing engine oil

(See illustrations 8 & 9)

Remove the riders seat, take out the two side cover top fixing bolts and lift the cover clear at the bottom rubber mounting. Drain the oil from the tank by removing the oil tank drain plug (illustration 6, item A). This should be carried out when the oil is warm so that it flows more freely from the tank. The crankcase drain plug (illustration 9, item A) should be removed and the small amount of oil in the sump allowed to drain off.

Replace the oil tank and crankcase drain plugs. Fill the tank to the dip stick level with fresh oil and run the engine at a steady speed to check the oil circulation. The oil level should not exceed the "H" mark or fall below the "L" on the dipstick.

As the oil in the sump has been drained off, a moment or two will elapse before the scavenge side of the pump begins to return the oil to the tank. Run the engine for three minutes, then stop the engine and allow the oil to settle in the tank for a further two minutes. Recheck the oil level and top up as required. Finally refit the side panel.

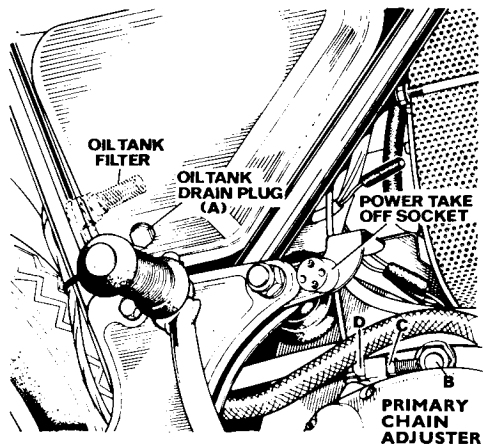

ILLUSTRATION 8

## Removing oil tank

Remove the riders seat, take out the two side cover top fixing bolts and lift the cover clear at the bottom rubber mounting. Drain the oil as described before under the heading "Changing engine oil". Remove the fuel tank after releasing the rear fixings, removing the two forward mounting nuts and disconnecting the fuel lines from the taps.

Slide the rubber oil pipes off the stubs on top of the oil tank breather space and filler neck. Remove the large filter bolt at the banjo at the rear end of the oil tank and collect the two large washers for re-use. Pull the return oil pipe with ferrules clear of the oil tank metal pipe. Disconnect the chain oiler pipe.

Remove the top rear mounting nut, leaving the bolt, rubber and washers in position. Slacken the front mounting nut only (the tank bracket is slotted). Remove the bottom bolt completely. The tank is now free. Pull the bottom clear then slide the tank forward whilst continuing to lift. Reverse these processes to assemble.

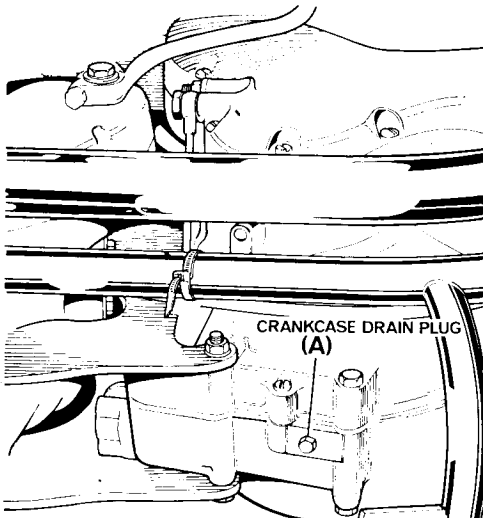

ILLUSTRATION 9

## Oil tank filter

(See illustration 8).

A coarse mesh metal filter is incorporated with the oil feed pipe fixing bolt, which should be cleaned at 2,500 miles intervals when the oil is changed.

## Cartridge type oil filter

(See illustration 10)

After the first 500 mile service, this filter should be changed at least every other oil change. The filter (shown shaded) is located behind the gearbox, between the Isolastic mounting plates. To change, remove screw clamp, place oil drip-tray under filter and unscrew. Remove filter and old sealing ring. Moisten new sealing ring with oil and install filter hand-tight only. Replace screw clamp.

## Rear chain lubrication

A non-adjustable automatic chain oiler is provided lubricant being controlled by a felt pad restrictor to the rear of the oil tank.

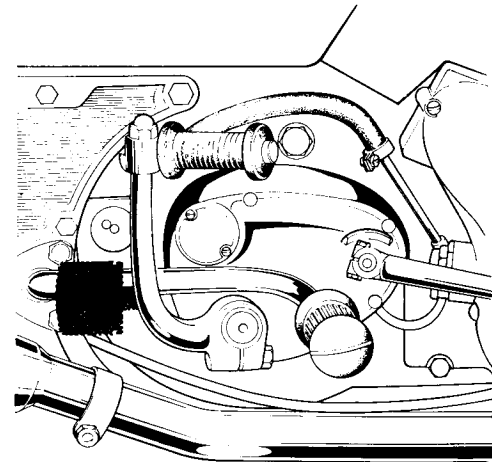

ILLUSTRATION 10

## Changing gearbox oil

(See illustration 3 on page 9).

The gearbox oil should be changed after a run so that the warm oil flows more freely. Remove the filler cap (C) and drain plug (A). Drain the oil into a suitable container. Replace the drain plug and fill the gearbox through the filler cap orifice (C) Allow time for oil pass through the inner cover into the shell. When the level plug is removed and oil runs from the level plug hole (B) allow the surplus oil to drain off and replace the level plug and filler cap.

## Changing oil in the primary chaincase

(See illustration 4 on page 10).

Remove the footrest and place a metal tray under the chaincase. Unscrew the central fixing bolt (A) and break the joint to allow the oil to drain into the tray. Wash out the case with clean paraffin. Refit the outer case and remove the filler cap, Pour in 7 fl. oz. (200 cc.) of fresh oil. Be careful not to overfill. Refit the filler cap and footrest.

## Changing oil in the front forks

(See illustration 11).

Under normal conditions the front forks will require no servicing other than an occasional change of oil. Should the oil level become low it will be indicated by excess movement of the forks, but only after considerable mileage.

Each fork leg is provided with a drain screw and each leg should be treated separately. Remove the drain screw, take care not to lose the small fibre sealing washer. Take the machine off the stand, apply the front brake and move the forks up and down to expel the oil. Allow a few minutes for draining and repeat the operation with the other leg. Whilst draining the right fork leg, the forks should be turned on full right lock. Conversely for draining the left fork leg.

Refit the drain screws, place the machine on the centre stand. Remove handlebars to improve accessibility.

Unscrew the large filler plug at the top of each leg, remove the speedometer and tachometer and lift the front wheel to expose the springs.

Support the wheel with a block of wood to hold the springs clear. Using two spanners, unscrew the filler plugs from the damper rods.

Remove the wooden block and allow the forks to extend fully. Pour in a measured 150 cc (5 fl. oz.) of oil into each leg. Because of the springs inside the main tubes the oil will be slow to run down.

Expose the springs again and before refitting the filler plugs to the damper rods ensure that their locknuts are screwed down to the bottom end of the thread on the rod. Lock the filler plugs and locknuts together then screw in and tighten the filler plugs.

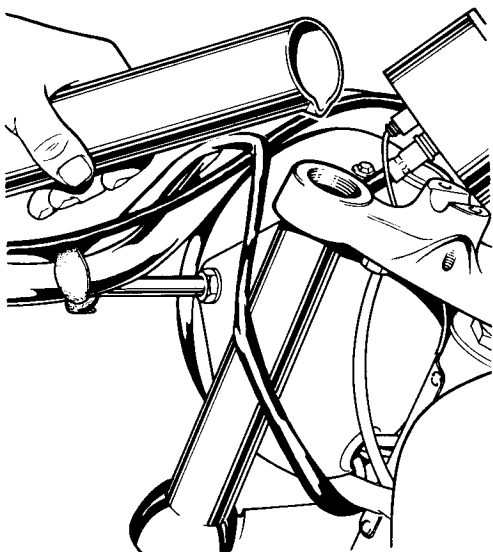

ILLUSTRATION 11

## Lubricating swinging arm bushes

(See illustration 3 on page 9).

For lubrication purposes, a grease nipple (D) is used on the plate covering the right side of the swinging arm bush housing.

To maintain the oil content, use a grease gun filled with S.A.E. 140 oil, inject oil sufficient to fill the cavity every 5,000 miles.

# Engine and ignition system

## Rocker clearances

The rocker clearances are measured by feeler gauges inserted between the end of the valve stem and the rocker adjusting screw. Release the two milled discs securing the rider's seat - draw the seat backwards to clear the frame and lift off.

Remove the fuel tank. This is attached to the frame by two nuts at the front and a rubber band fixing at the rear, except on Hi-rider which has two rear tank bolts and a cross strap replacing the rubber band. The two fuel pipes must be disconnected.

Remove the spark plugs and the three rocker covers on the cylinder head.

By means of the kick-starter pedal, rotate the engine until the left side inlet valve is fully open. With a 0.006 in. (0.015 mm) feeler gauge, check the rocker clearance of the right side inlet valve. If adjustment is necessary, slacken the right side rocker adjusting screw locknut (A) and screw the adjuster (B) out a couple of turns. Place the feeler gauge between the adjuster and the end of the valve stem and screw the adjuster in until it just nips the feeler gauge. Tighten the locknut and withdraw the gauge. It should not be tightly gripped but should slide easily through the gap.

Rotate the engine until the right side inlet valve is fully open and adjust the left side inlet valve in the same way.

Adjust the exhaust valve rocker clearances in the same sequence but using a 0.008 in. (0.2 mm) feeler gauge.



ILLUSTRATION 12

## Contact breaker points

(See illustration 13)

The Lucas contact breaker contains a separate contact set for each cylinder. Each contact set has its own mounting plate held to the circular base plate by two screws (A), each mounting plate being provided with a slot into which an eccentric headed adjusting screw (B) is fitted. When the securing screws are slackened, rotation of the eccentric screw moves the mounting plate in relation to the ignition cam. This permits a very accurate setting of ignition timing for each cylinder.

Another eccentric headed screw (C) is located in a slot in each fixed contact plate and provides adjustment for the contact breaker points.

The baseplate is secured by two screws in elongated holes. To advance the timing move the baseplate clockwise. To retard, move the baseplate anti-clockwise.

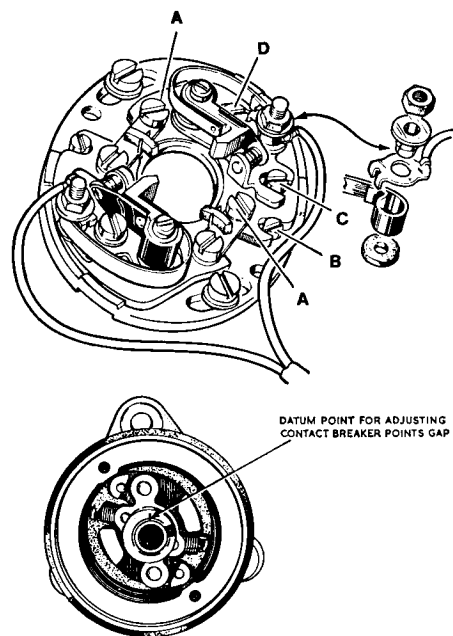

ILLUSTRATION 13

## Adjusting the contact breaker points gap

Remove the spark plugs so that the engine can be rotated easily by means of the kick start pedal. An examination of the cam will reveal a small mark adjacent to the slot. This mark assists in obtaining a uniform gap for each cylinder.

Rotate the engine until the nylon heel of the moving contact registers with this mark and the points will be in the fully open position. Using a 0.015 in. (0.38 mm) feeler gauge check the gap. If the adjustment is correct, the gauge will be an easy sliding fit. When adjustment is necessary, release the fixed contact plate locking screw (D), rotate the eccentric screw (C) until the correct gap is obtained. Retighten the locking screw. Adjust the other contact set in a similar manner.

## Maintenance

Every 5,000 miles (8,000 kilometres) the contact breaker points should be examined to determine their condition. Remove the nut securing the contact breaker spring to the anchor post and lift off the spring heel, together with the terminals, insulating bush and the insulating washer. Remove the fixed contact plate locking screw and take off the fixed contact plate.

Points which are slightly burnt or pitted can be smoothed with a fine carborundum stone and afterwards cleaned with a brush moistened in petrol or white spirit; if they are badly affected they should be renewed.

Before reassembly, smear the contact breaker pivot post and the cam very sparingly with Retinax 'A' grease and add three drops of engine oil to each lubricating felt. When reassembling ensure that the insulating washer, contact breaker spring, terminal and insulating bush are fitted in the order shown in *illustration 13* and that the terminal tags are inside the curve of the spring.

## Auto advance unit

The auto advance unit automatically and progressively advances the ignition timing as the engine speed increases and returns it to the fully retarded or static position when the engine stops.

To expose the mechanism, it is necessary to remove the contact breaker plate complete, but before doing so mark the exact position of the plate so that when it is refitted the timing is not disturbed.

Remove the contact breaker plate fixing screws and take off the plate complete with the contact sets. Ensure that the springs of the auto advance unit are intact with the taper loops attached to the pins. Check the automatic action by turning the cam by hand to the fully advanced position in which the bob weights will be fully extended. When the cam is released, the springs should return the bob weights to the static position.

Lubricate the mechanism sparingly at the point where the cam turns on the base plate. Do not over lubricate as an excess of oil may reach the contact breaker points. If the contact breaker plate has been removed from its original position without being marked, the ignition timing should be checked and reset when the plate has been refitted.

## Engine camshaft chain

(See illustrations 14 & 15).

Have available timing cover gasket 06.1092.

To examine, or adjust camshaft chain, the timing cover must be removed by:-  
Disconnect oil union for rocker box oil pipe from timing cover.

Remove cap covering contact breaker cover (two screws).

Remove contact breaker base plate - with wires attached (two hexagon bolts).

Remove auto advance unit - use extractor bolt 06.0934.

Remove 12 screws securing cover. Tap lightly the joint face to break seal, withdraw the cover.

When the cover is removed oil will seep from drilling in crankcase. Blank off drilling. (See illustration 14).

The camshaft chain (*illustration 15*) is provided with a slipper tensioning device (A). To adjust the chain, release the two nuts (B) securing the slipper, and move as required. The permissible amount of free up and down movement measured in the centre run of this chain is  $\frac{3}{16}$  in.

Check chain tension in more than one position.

Retighten the two tensioner nuts when the correct adjustment has been made.

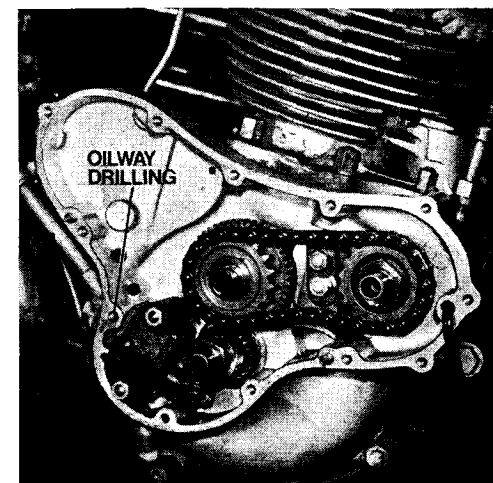

ILLUSTRATION 14

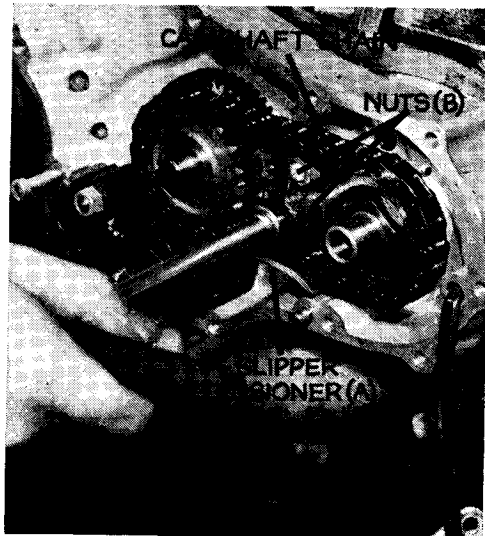

ILLUSTRATION 15

## Refitting the timing cover

Use a new gasket to guard against oil leakage. Screw oil seal guide (supplied in tool kit) into camshaft. Put back the timing cover, firmly tighten the 12 screws.

Remove inspection cap on primary chain case to expose indicator plate.

Position the engine on the drive side cylinder with the piston at top dead centre on the firing stroke (both valves closed) until the machined mark on the rotor registers with 28° on indicator plate.

Insert the auto unit with the rivets for the bob weights in line with the two screw holes for the contact breaker cover – the slot in the cam face should be at approximately 9 o'clock.

Fit the contact breaker base plate – yellow and black lead is for the drive side cylinder.

Reset ignition timing as described on page 25.

When the timing cover has been refitted, pour oil into the inlet rocker box fill full, then replace the rocker cover. Oil will then drain gradually through the rocker box drain hole into the timing case, thus providing initial lubrication for the timing gear until oil accumulates normally when running.

## Spark plug

It is most important to use the correct grade of spark plug, as a spark plug with a low heat factor can cause pre-ignition and subsequent damage to the engine (see *Technical data on page 4*).

To avoid damage to the insulator, use the plug spanner provided in the tool kit to remove and refit the spark plug, which should be firmly tightened to ensure a gas tight joint.

To adjust or reset the spark plug gap, this is effected by bending the earth, or side wire, which is ductile.

Before refitting the plugs, see that the sealing washers are sound, and clean the threads of the spark plug body.

A smear of graphite grease applied to the threads of the plug will assist in subsequent removal.

## Ignition timing

(See illustration 16).

To check or reset the ignition timing, a timing indicator plate is attached to the outer position of the primary chaincase, with a corresponding mark on the rotor for the alternator, which is exposed by removing the screwed cap adjacent to the indicator plate. Timing can be checked with the engine stationary, or with the engine running by using a Stroboscope.

## Engine stationary

Remove both spark plugs.

Remove inspection cap on chaincase.

Remove contact breaker cover – check and adjust contact breaker points as described on page 22.

Temporarily lock auto advance unit in the full advanced position by:  
removing the central fixing bolt.

Take off the washer for this bolt, replace it with one with a hole large enough to clear the central portion of the unit to bear on the cam when the central bolt is tightened.

Replace the central bolt with washer – hold the auto unit in the full advanced position – tighten the bolt.

Rotate the engine until the machined mark on the rotor registers with the 28° on the indicator plate. If the timing is correct – the contact points should commence to separate.

The exact point of separation can be determined by inserting a strip of very thin paper between the points. The points will grip the paper when closed – by moving the engine slowly, a light pull on the paper will indicate the exact point of separation. Safeguard against a shred of the paper being trapped between the points.

As an alternative, use a low wattage bulb and holder with a short length of wire soldered to the bulb body with a second length of wire attached to the bulb connection, with crocodile clips attached to the ends of both wires.

Connect one wire to the contact breaker spring of the points that are being checked the second wire should be attached to a suitable earth point on the engine.

Switch on the ignition and by moving the engine the bulb will light immediately the contact points separate.

To adjust the timing, refer to sub heading 'Contact Breaker Points' (page 22).

Remove central fixing bolt – discard washer temporarily used – fit the bolt with its original washer and tighten.

## Engine running

To check the timing with a Stroboscope see instructions in the Workshop Manual.

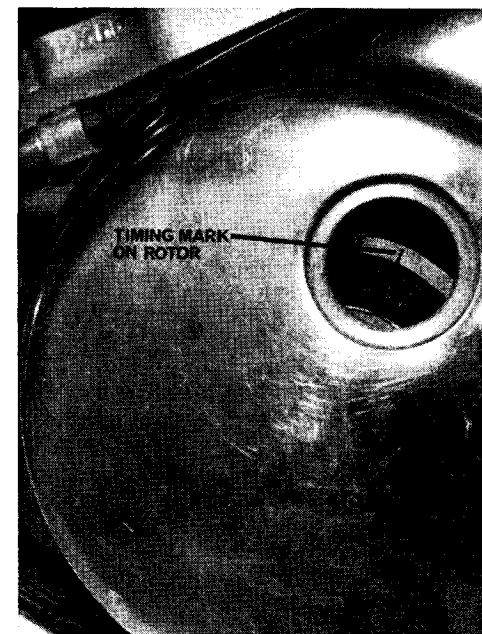

ILLUSTRATION 16

NOTE: A special service washer 06-0949 is available to temporarily lock the auto advance unit whilst the ignition timing is being checked.

# Transmission

(See illustrations 4 & 7).

## Adjustment of primary chain

The primary drive from the engine to the gearbox is by triple row chain; as the chain operates in an oil bath, long life and reliability are ensured provided that correct adjustment is maintained and the chaincase oil level maintained by topping up at regular intervals. If the chain is too tight the engine and gearbox bearings will be overloaded, and if the chain is too loose there will be excessive wear of both the chain and the sprockets: in either case maladjustment will cause excessive transmission noise.

Tighten the primary chain by:

Slacken (*illustration 8, item B*) gearbox top fixing bolt from right hand side. Slacken the nut on the gearbox bottom bolt.

Slacken front nut (C) on the adjusting eye bolt. (Two or three turns).

Remove filler cap from primary chaincase (*illustration 4, item C*).

Tighten the rear nut (*illustration 8, item D*) on adjusting eye bolt until, with the finger through the filler cap orifice, it can be felt that the chain is dead tight. Then slack off the rear nut and carefully tighten the forward nut until there is a total up and down movement of  $\frac{3}{8}$  in. Then securely tighten the rear nut to lock the assembly. Check the adjustment in more than one position of the chain and adjust, as above, at tightest place.

It is important that these instructions to over tighten and then slack off are carefully followed.

Tighten nut on gearbox top and bottom fixing bolts. The top bolt, with lubricated thread should be secured to 70lb ft torque, from the right hand side. Do not attempt to turn the nut at the left.

Replace chaincase filler cap.

## Adjustment of rear chain

(See illustration 16).

Slacken the rear wheel spindle nuts (A) and release the chain adjuster locknuts (B). Pull downward on the bottom run of the chain to bring the spindle hard up against the adjusters (C). Move each adjuster an equal amount until, with a rider seated, there is a total up and down movement, measured in the centre of the chain run, of  $\frac{3}{4}$  to 1 in. (19.05 to 25.4 mm). Tighten the chain adjuster locknuts and the wheel spindle nuts.

Check rear brake adjustments. (See page 32).

If the chain has covered a considerable mileage it may have worn unevenly; the adjustment should be checked at the highest part of the chain run.

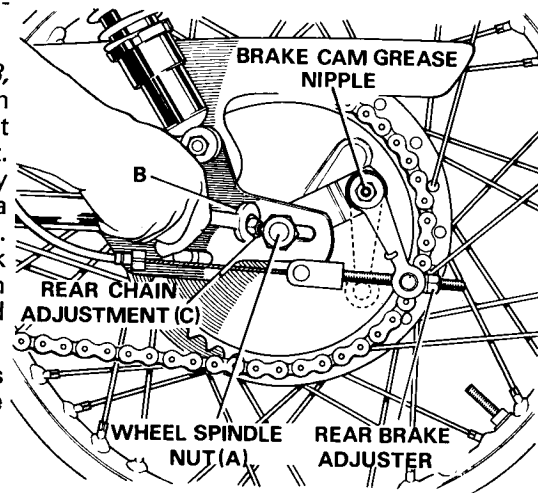

ILLUSTRATION 17

# Front forks and rear suspension

The front forks are of the spring controlled, oil damped, variety. The only routine attention required is a periodic oil change as detailed on page 18.

The bearings are of the ball journal type, pre-packed and sealed for life. These bearings require no adjustment at all. Unlike earlier models, the fork stem is fixed to the top yoke, the stem nut being fitted below the lower yoke.

The Girling rear suspension units are sealed units filled with oil on assembly. They should require no further attention.

A cam-ring adjuster is provided to raise the base of the springs into three alternative positions to suit varying loads. The 'soft' or normal solo position is when the adjuster is rotated as far as possible in an anti-clockwise direction when viewed from above.

# Clutch

(See illustrations 3 & 17).

The diaphragm spring clutch is mounted on the gearbox mainshaft and operated by a push rod which passes through the hollow mainshaft.

The clutch operating lever is controlled by the handlebar lever. Movement imparted to the push rod by the operating lever causes the clutch plates to separate.

The clutch plates are compressed by a circular diaphragm spring, thereby ensuring an even distribution of spring pressure.

To enable the clutch to operate satisfactorily, there must be a little free movement between the operating lever to which the clutch cable is attached and the push rod, in addition to the  $\frac{3}{16}$  in. to  $\frac{1}{4}$  in. of free play in the clutch cable itself.

If this free play is absorbed by the friction plates settling down, clutch slip will develop. Conversely, if the free play is excessive, the clutch plates will not separate, causing clutch drag.

To ensure that this free movement exists, slacken off the clutch cable adjuster at the handlebar end as far as possible and then take off the filler cap (illustration 3, item C) on the gearbox outer cover.

With the index finger, move the operating lever to which the clutch cable is connected inside the kick starter case to and fro, which will indicate whether there is a slight movement or otherwise.

If no movement exists, remove the clutch inspection cap on chaincase (illustration 18) and release the nut (B) on the gearbox mainshaft, then turn the screw (C) gently in an anti-clockwise direction until movement is felt on the operating lever. Then turn screw (C) in a clockwise direction until it is felt that the screw just touches the push rod.

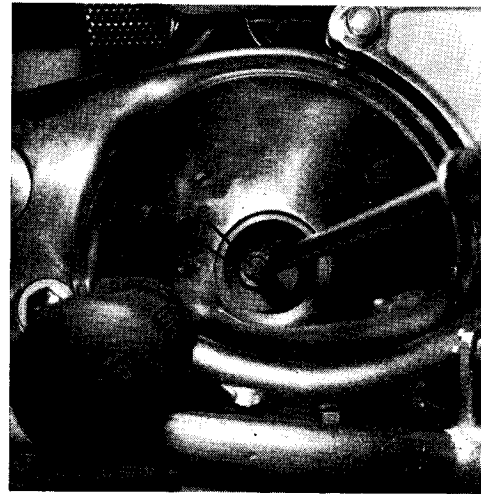

ILLUSTRATION 18

Now unscrew the screw (C) one full turn and holding it in this position, retighten the lock nut (B). This will ensure that there is the specified amount of movement between the clutch operating mechanism and the push rod.

Finally, unscrew the clutch cable adjuster at the handlebar end leaving a minimum of  $\frac{1}{8}$  in. free movement between the cable outer casing and the adjuster.

**WARNING:** Do not attempt to dismantle the Diaphragm Spring Clutch without the proper tools as serious personal injury could result. (Refer to the Workshop Manual).

# Carburetors

The Commando is fitted with twin Amal concentric carburetors series 900.

The carburetor settings and jet sizes shown in the technical data have been determined after long tests to obtain maximum performance consistent with good petrol consumption.

It should not be necessary to alter the carburetor settings unless the machine is operating at altitudes over 3,000 feet above sea level.

An instructional leaflet issued by Messrs. Amal (list No. 117/3) is issued with each new Commando and describes the function of the carburetors and the method of tuning.

## Synchronising the twin carburetors

It is most important that both throttle slides should operate simultaneously. To ensure this, slacken the throttle stop screws and adjust the throttle cables until there is a minimum of backlash but on initial movement of the twistgrip, both throttle slides begin to lift simultaneously. Make sure the throttle cable adjuster lock-nuts are tightened securely. Now start the engine and detach one spark plug lead. Adjust the pilot air screw and throttle stop screw to gain satisfactory idling. Refit this spark plug lead. Remove the other and adjust idling on the second cylinder. When this plug lead is replaced and the engine is again running on two cylinders, idling speed may be too fast, in which case the throttle stop screws should be unscrewed slightly until idling is correct.

## Cleaning the carburetors

The float bowl on each carburetor is retained by two screws, which when removed will enable the bowl to be removed for cleaning.

## Air filter

(See illustration 19).

To remove and replace air filter element:

Take out the two bolts securing the air filter front plate.

Lever the front filter plate outwards at the bottom without disconnecting the power socket. The plate can then be pulled clear of the element. Take out the filter element from the left side. (See illustration 19).



ILLUSTRATION 19



# Wheels

## DRUM BRAKE FRONT WHEEL

### Removal of front wheel

(See illustrations 20 & 21).

Support the machine with the front wheel well clear of the ground. Disconnect the brake cable by removing the clevis pin (A) (illustration 21) at the operating lever (B) and unscrewing the adjuster (C) from the brake plate. Slacken the fork end clamping nut (illustration 20, item A) and remove the wheel axle nut (illustration 21, item D). Take the weight of the wheel in one hand and withdraw the wheel axle using a tommy bar in the axle hole.

### Refitting front wheel

Reassemble in the reverse order. Grease the wheel axle when refitting and make sure that the torque stop (illustration 21, item E) is properly engaged. Before tightening the fork end clamping nut, compress the forks a few times to centralise the axle. Do not overtighten the nut as there is a danger of fracturing the lug. Reconnect and adjust the brake cable. If the fork motion is stiff, slacken the axle nut and fork end clamping nut and move the forks up and down to allow the fork tubes to take up alignment. Retighten the nuts.

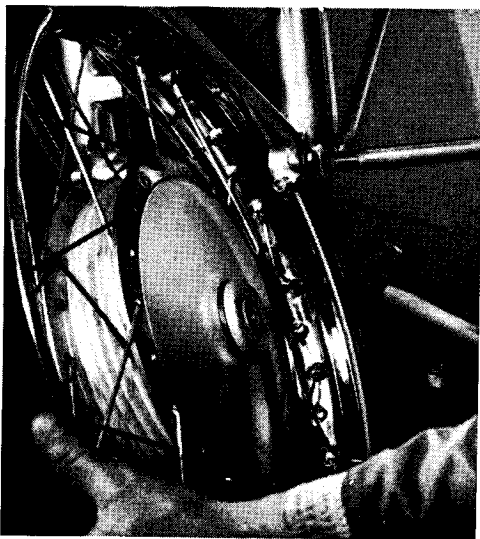

ILLUSTRATION 20

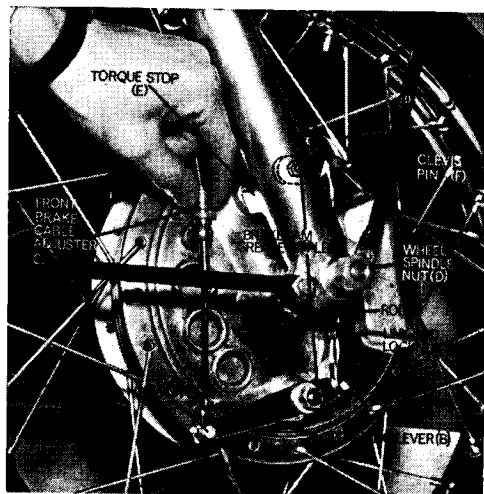

ILLUSTRATION 21

# Wheels

## DISC BRAKE FRONT WHEEL

### Removal of front wheel

Removal of front wheel (see illustrations 22 and 23). Support the machine with the front wheel well clear of the ground.

The brake assembly remains undisturbed since only the disc is removed with the wheel.

Slacken the fork end clamping nut (illustration 22, item A) and remove the wheel axle nut (illustration 22, item B). Take the weight of the wheel in one hand, withdraw the axle using a tommy bar, and withdraw the wheel forwards to disengage the disc from the pads.

To prevent the brake pads being ejected by unintentional application of the brake with the wheel removed, place a  $\frac{1}{4}$  in. (6.7 mm) thick spacer of clean wood or metal between the pads.

Collect the wheel bearing dust covers to prevent loss. (See illustration 23).

### Refitting front wheel

Offer the wheel with both dust covers in position and, with care, guide the disc between the brake pads (see illustration 24)

Grease the wheel axle when refitting. Before tightening the fork end clamping nut, compress the forks a few times to centralise the axle. Do not overtighten the nut as there is a danger of fracturing the lug. If the fork action is stiff, slacken the axle nut and fork end clamping nut and move the forks up and down to allow the fork tubes to take up alignment. Retighten the nuts.

N.B. When removing or refitting the tire, do not rest the wheel on the disc side or damage may be caused.

It is essential to apply the brake lever several times after the wheel has been refitted in order to restore full pressure before the brake is returned to service.

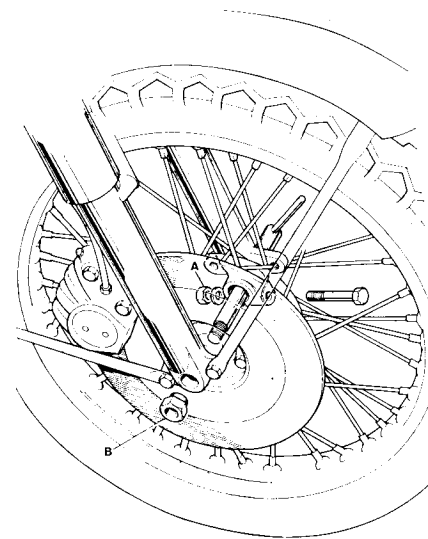

ILLUSTRATION 22

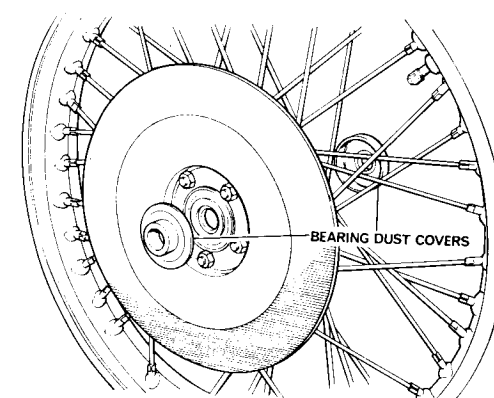

ILLUSTRATION 23

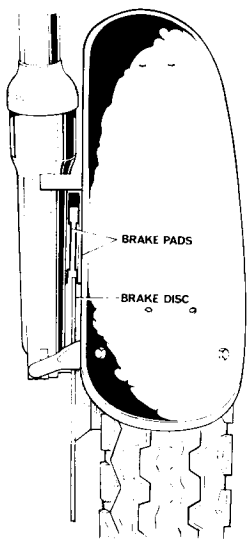

ILLUSTRATION 24

### Removal of rear wheel (See illustration 25).

The rear wheel is removed by detaching it from the brake drum, leaving the drum, rear sprocket and chain in position.

Disconnect the speedometer drive cable (A). Unscrew the wheel axle (B) at the right hand side and withdraw. The spacer (c) and speedometer drive gearbox (d) will come away as the axle is withdrawn. If the wheel is difficult to remove, use a lever between the wheel and brake drum. This will separate the three paddles from the shock absorbing pads in the hub.

At each 5,000 mile interval examine and, if necessary, replace the shock absorbing pads.

### Refitting rear wheel

When refitting the wheel, turn the brake drum so that one of the three paddles is approximately in line with the pivoted fork tubes and so facilitate passing the bearing boss on the hub over the other two paddles. Fit the wheel to the paddles, fit the speedometer drive gearbox, exercising care to engage the two drive dogs with the slots in the hub bearing ring.

Position the spacer – fit the wheel axle with its washer, apply the rear brake fully to centralise the brake shoes and whilst holding on, tighten the axle fully.

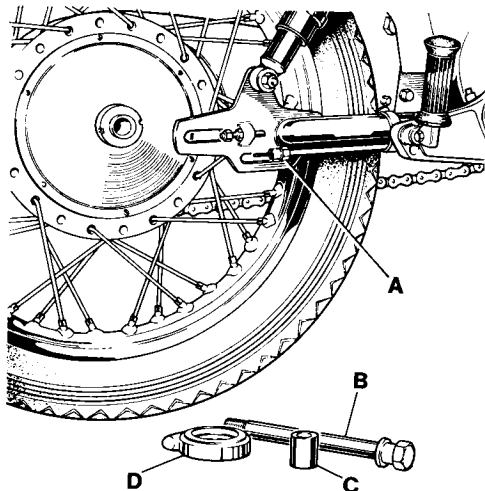

ILLUSTRATION 25

# Brakes

### Rear brake adjustment (See illustration 26).

The rear brake is adjusted by means of the cable adjuster at the operating lever. When the brake is fully applied the operating lever should be approximately in the position shown in broken lines in the illustration. If excessive brake lining wear brings the lever past this position and there is no adjustment left, the brakes should be relined.

After adjustment the wheels should rotate freely. Any tendency to bind will dissipate power and promote heat which will adversely affect the efficiency of the brakes.

A rear brake cable is fitted instead of a brake rod to cope with the flexibility of the engine cradle and swinging arm relative to the main frame on which the rear brake pedal is mounted. For this reason, a rod should not be substituted under any circumstances.

### Disc brake maintenance

The disc brake functions by the pressure of friction pads against the disc attached to the front wheel hub. As the brake handlebar lever is applied, brake fluid from the master cylinder reservoir is forced through the brake line to the caliper to force the friction pads against the disc.

The brake requires no adjustment since wear on the pads is compensated for by extra brake fluid passing from the master cylinder reservoir into the system.

Should the brake become "spongy" in operation or have excessive lever travel, the brake hydraulic system should be examined and rectified by your Norton dealer.

### Disc brake—bleeding and flushing

#### Bleeding procedure

Purging of air from a hydraulic system, commonly known as 'bleeding', should only be necessary when some part of the system has been disconnected, or after the fluid has been drained off and renewed. However, in normal service, should the presence of air in the system be indicated by a 'spongy' brake effect, the cause should be traced and rectified.

### Braking system

Fill the master cylinder supply tank with Lockheed series 329 brake fluid, and keep topped up throughout the operation, otherwise air may be drawn into the system, necessitating a fresh start.

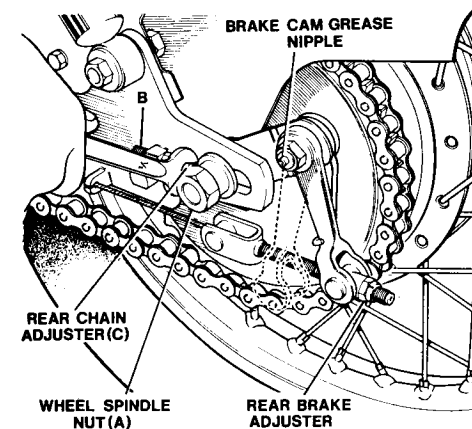

ILLUSTRATION 26

Attach a suitable length of clean rubber or plastic tubing to the bleeder screw of the hydraulic unit, and allow the other end of the tube to be submerged in a small quantity of new fluid contained in a glass jar. Open the bleeder screw half a complete turn (*illustration 27*).

Apply the brake slowly, allowing it to return unassisted. Repeat the pumping action, with a slight pause between each stroke. When stopping the pumping action such as for refilling the master cylinder or when clear fluid, free of air bubbles, emerges from the tube, tighten the bleeder screw whilst the brake lever is fully pulled to the handlebar.

Verify that the master cylinder supply tank is replenished to the correct level.

**FLUID BLED FROM THE SYSTEM MUST BE DISCARDED.**

### Flushing procedure

Every eighteen months, or after every 24,000 miles, whichever occurs first, the fluid in the hydraulic system should be renewed with the Lockheed series 329 brake fluid.

Brake fluid, particularly disc brake fluid, absorbs water from the atmosphere; accordingly, fluid must only be exposed during the time taken to fill the system. It is also most important that the greatest care is taken to prevent dirt from entering the system during the filling operation.

Follow the 'bleeding' procedure until new clean fluid emerges from the flexible tube, thus establishing complete renewal of the fluid.

If the fluid in the system is contaminated by mineral oil or other spurious fluid, the complete hydraulic system must be stripped. Hydraulic assemblies must be renewed or overhauled as detailed in the workshop manual, and flexible hoses replaced. Furthermore, ensure that all metal fluid pipes are cleaned thoroughly before reassembling.

### Drum type front brake adjustment

(See *illustration 21* on page 30).

A cable adjuster is provided at the handlebar lever and another at the brake drum (C). The link rod is correctly set on assembly and should not be interfered with unnecessarily.

To set the rod, take out the top clevis pin (F) and with the help of an assistant pull both operating levers until the shoes are in contact with the drum. Slacken the link rod locknut (G) and screw the rod (H) in or out until, with the shoes still in contact with the drum, the clevis pin can be refitted; then retighten the link rod locknut. Subsequent adjustment should be carried out on the cable adjuster.

The clevis pins should be replaced if they become excessively worn, otherwise the efficiency of the brake will be impaired.

The front brake air scoop entry and outlet are intentionally blanked off by sealing plates. For additional cooling in a hot climate or for track racing, these plates can be removed.

Use suitable washers under the screw heads to secure the metal gauze mesh.

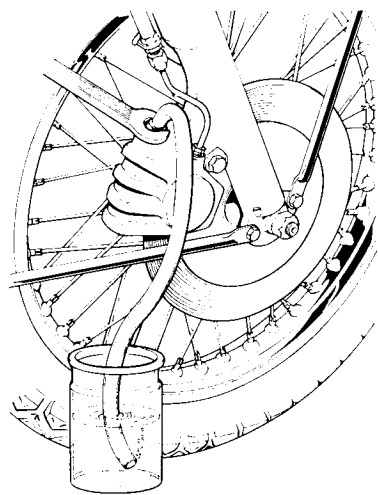

ILLUSTRATION 27

## Electrical equipment

### Ignition system

The Commando is equipped with a 12 volt electrical system but uses 6 volt ignition coils with a ballast resistor so that an adequate spark is available even under the most adverse conditions.

Should the battery fail completely the electrolytic capacitor will provide starting, running and direct lighting, supplementary accessories such as parking lights being excepted.

### Capacitor (Lucas 2MC)

The capacitor is an electrolytic polarised type spring mounted to the rear of the battery and it is important that the correct wiring connections are made. The connections are dissimilar in size, the  $\frac{3}{16}$  in. (4.76 mm) connector being the positive ground terminal with the connection rivet marked in red. The  $\frac{1}{2}$  in. (6.35 mm) double terminal is the negative. The capacitor must always be fitted with the terminals downwards.

A faulty capacitor may not be apparent when the battery is connected in circuit and it is advisable to check periodically that it is serviceable by disconnecting the battery. The machine should start in the usual manner and full lights should be available with engine running.

### Alternator (Lucas RM21)

The alternator consists of a rotor and stator, the rotor being driven from the drive end of the crankshaft. The whole assembly is housed within the primary chaincase. The stator windings are in bonded resin and need no attention except to check the snap connectors.

### Rectifier (Lucas type 2DS506)

The rectifier converts the alternating current generated by the alternator into direct current for charging the battery. It requires no attention except to ensure that the fixing nut is tight. The nuts

holding the plates together must on no account be interfered with as their tension has been carefully set during manufacture to give the best possible rectifier performance. The rectifier is attached to the rear of the frame and is accessible when the seat is removed.

### Ballast resistor

The ballast resistor is located across the front of the ignition coil mounting. Its function is to protect the 6 volt ignition coils from damage by an otherwise 12 volt system.

The resistor requires no maintenance other than an occasional check on the security and cleanliness of the terminals.

### Battery (Lucas NV or YUASA)

The 12 volt positive-earthed battery has a capacity of 8 ampere/hours. At two week intervals, more frequently in hot climates, the level of the electrolyte should be checked. If necessary, add distilled water to maintain the level indicated on the side of the transparent battery case. Do not use tap water as this may contain impurities harmful to the battery. Never use a naked light when examining the cells. (*Illustration 5, page 10*).

If the machine is to be out of use for a lengthy period, have the battery fully charged and give it a short refreshing charge at 1 ampere about every two weeks. This will suffice to keep the battery in serviceable condition. When the battery is fully charged, the specific gravity of the electrolyte should be 1.270/1.290 at 60°F (16°C).

The battery terminals (red positive earth: brown/blue live) must never be reversed otherwise the equipment will be damaged.

The Company cannot accept responsibility for damage to parts caused by acid as a result of overfilling.

The vent pipe must be kept connected to the battery.

## **Running with battery disconnected**

Before running the machine with the battery disconnected, the battery negative lead must be insulated to prevent it shorting to earth on any part of the machine.

## **Fuses**

A 35 amp. fuse is fitted in the negative battery lead close to the battery terminal.

## **Zener diode**

(Located on right side footrest plate). When the battery is in a low stage of charge, the zener diode allows current from the alternator to reach the battery until it becomes fully charged, when the current is diverted to the zener diode.

If an electrical load such as the lighting system is switched on, a reduced amount of current flows through the diode, the balance being diverted to feed the load. If the load is heavy enough, the diode will become virtually non-conductive and the whole of the current generated by the alternator will go to meet the demands of the battery and equipment.

If the zener diode is disturbed it is important that the fixing nut is tightened to a torque loading of not more than 28 in/lb and not less than 24 in/lb. In addition the seating face must be true and free from burrs. It is most important that the earth lead is not fitted between the face of the zener diode and the footrest plate.

## **Direction indicator set**

(All Interstate and other models as market requirement)

Flashing direction indicators are provided front and rear, operated by the switch on the right handlebar control cluster.

The flasher unit (Lucas type 8FL) is located beneath the seat. The flasher unit requires no maintenance, being a sealed unit.

## **Capacitor pack**

The two condensers are mounted in a rubber covered capacitor pack (Lucas type 2CP) which is mounted behind the ballast resistor on the coil cluster bracket. The rubber cover can be removed easily to gain access to the individual condensers.

## **Charge warning light assmulator**

The assmulator is cylindrical in form and is mounted in an anti-vibrational spring beneath the frame rails. The unit is sealed and requires no attention though whenever the tank is removed or the throttle or clutch cables are changed, the security of the spade terminals should be checked.

# **Light Bulbs**

## **Headlamp (SS700P or MCH 66)**

The type of bulb fitted may be varied to suit the lighting regulations of different countries.

### **Bulbs:**

USA, UK, etc.

Type 370

12 volt 45/40 watt, transverse duplo pre-focus, vertical dip.

Continental (not France)

Type 410

12 volt 45/40 watt, duplo "D" vertical dip, pre-focus.

France only

Type 411

12 volt 45/40 watt, duplo "D" vertical dip, yellow, pre-focus.

To gain access to the bulb, unscrew the front headlamp rim fixing screw at the top of the rim. Take off the front rim and light unit, removing the upper part first. Remove the adaptor by pressing inward and turning to the left. The bulb can now be taken out. On Continental headlamps, pull the adaptor free of the bulb and release the bulb retaining clip to remove the bulb:

## **Parking light**

Lucas 12 volt 6 watt No. 989.

Remove the light unit assembly as described above. The bulb holder is a push fit in the reflector.

## **Indicator repeater light, Ignition warning light, Hi-beam warning light**

Lucas 12 volt 2 watt No. 281.

Remove the light unit assembly as described above. The bulb holder is a push fit in its housing. To remove the bulb, press in and turn.

## **Stop/tail lamp**

Bulb Lucas 12 volt 6/21 watts No. 380.

Remove the lens by unscrewing the two retaining screws. The bulb has offset securing pins to ensure correct location in the bulb holder. To remove the bulb, press in and turn.

## **Speedometer bulb**

12 volt 2.2 watts No. 643.

The bulb holder is merely a push-in fit to the bottom of the instrument and the bulb a bayonet fitting into the holder.

## **Tachometer bulb**

12 volt 2.2 watts No. 643.

Bulb removal is similar to that for the speedometer.

## **Direction indicator bulb**

Lucas 12 volt 21 watts.

Care must be taken when refitting the lenses that the screws are not over-tightened, resulting in splitting.

# Tracing trouble

Engine fails to start, or is difficult to start, may be due to :

Ignition not switched on.  
Electrical short.  
Water on high-tension coils or contact breaker.  
Moisture on spark plugs.  
Oiled up, or fouled, spark plugs.  
Throttle opening too large.  
Carburetor pilot jet choked.  
Air lever in open position or bad air leak at carburetor joints.  
Lack of fuel because of insufficient flooding.  
Lack of fuel because pipe, or tap, obstruction.  
Excessive flooding of carburetor (with hot engine only).  
Valve not seating properly.  
Contacts points dirty.  
Incorrect contact point gap.

Engine misfire may be due to :

Defective or oiled spark plugs.  
Defective engine-to-frame earth wire.  
Defective spark plug wire.  
Incorrect contact point gap.  
Contact breaker points loose.  
Oil on contact breaker points.  
Rocker adjustment incorrect.  
Water in carburetor.  
Air filter clogged.  
Broken wire shorting on frame.  
Partially obstructed petrol supply.  
Disconnected carburetor balance pipe.

Loss of power may be due to :

Faulty spark plugs.  
Lack of oil in tank.  
No rocker clearance, or too much clearance.  
Weak or broken valve spring.  
Sticky valve system.  
Valve not seating properly.  
Brakes adjusted too closely.  
Badly fitting or broken piston rings.  
Punctured carburetor float  
Engine carbonised.  
Retarded ignition.  
Clogged air filter.

Engine overheats may be due to :

Lack of proper lubrication. (Quality or quantity of oil).  
Faulty spark plugs.  
Air control to carburetor out of order.  
Punctured carburetor float.  
Engine carbonised.  
Weak valve springs.  
Pitted valve seats.  
Worn piston rings.  
Ignition setting incorrect.  
Automatic timing control faulty.

Engine stops suddenly may be due to :

Water on high tension coils or spark plugs.  
Loose coil connections  
No petrol in tank, or choked petrol supply. Vent hole in petrol tank filler cap choked.  
Choked main jet.  
Water in carburetor float chamber.  
Oiled up or fouled spark plugs.

## Excessive petrol consumption

Excessive petrol consumption may be due to :

Leaks in the petrol feed system. (Damaged fibre washers, loose union nuts on piping, defective float needle action).  
Incorrect ignition setting. (Ignition not advanced sufficiently).  
Defective valve action or burnt valves.  
Incorrect use of air control lever.  
Moving parts of carburetor badly worn. (Only possible after very considerable mileage).  
Bad air leak at carburetor junction or inlet manifold joint.  
Air filter clogged with dirt or oil.

## Steering unsatisfactory

Wheels out of alignment.  
Front and/or rear tire tread not correctly manipulated to run true with wheel (causes handlebar oscillation at low road speed).  
Excessive luggage mounted too high or too far back.

## Abnormal tire wear

Abnormal tire wear may be due to :

Incorrect tire pressure.  
Wheels not in alignment.  
Harsh driving methods. (Misuse of acceleration and braking).

## Disc brake "spongy"

Air in brake hydraulic system.  
Brake requires bleeding.

This handbook is designed to enable the owner to get the best out of his NORTON motorcycle. Your nearest Norton dealer will be ready to help with service and advice.